

GLOBO

LIGHTING

www.globo-lighting.com

67247-58

- Step-1** **B**
- ON
3000K
- Step-2**
- OFF
- Step-3**
- ON
4000K
- Step-4**
- OFF
- Step-5**
- ON
6500K

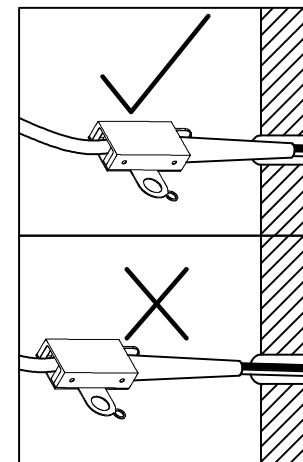
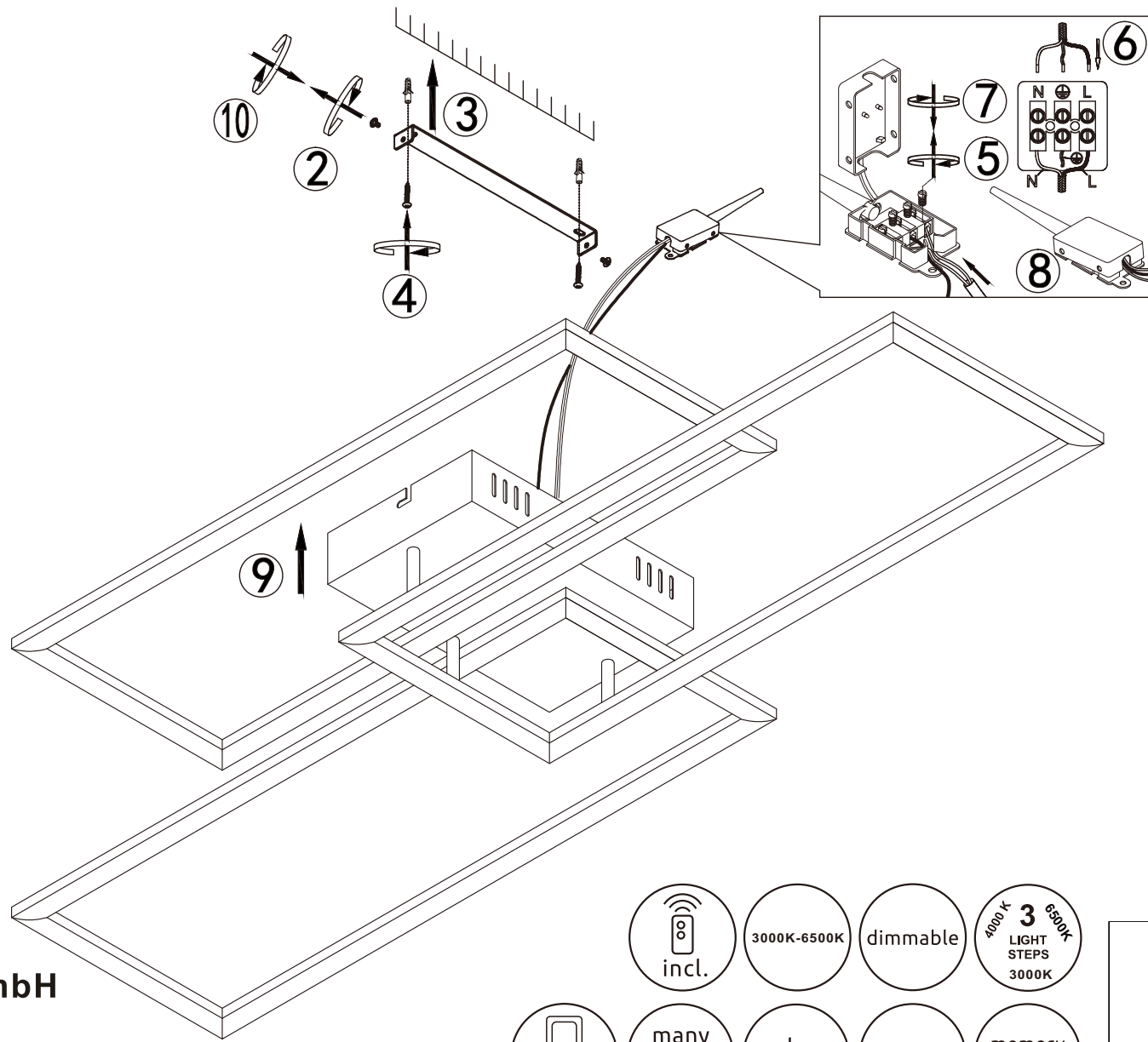

GLOBO Handels GmbH
Gewerbestr. 3
A-9184 Sankt Peter
AUSTRIA

- incl.
- 3000K-6500K
- dimmable
- 4000K 3 LIGHT STEPS 6500K 3000K
- many steps
- many light steps
- colour fixing
- night light
- memory function

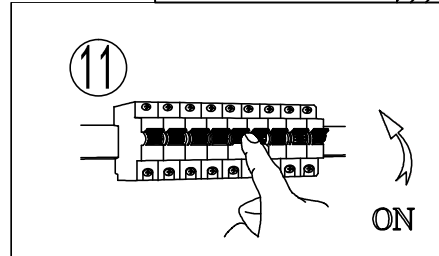

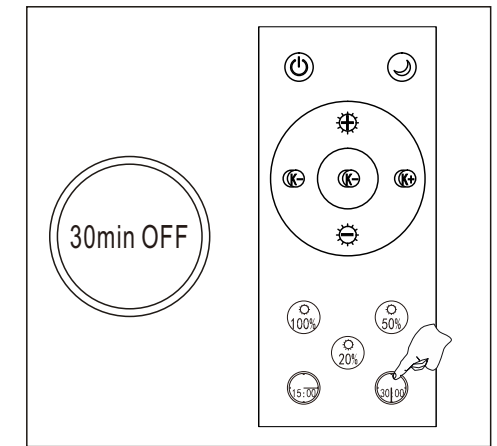
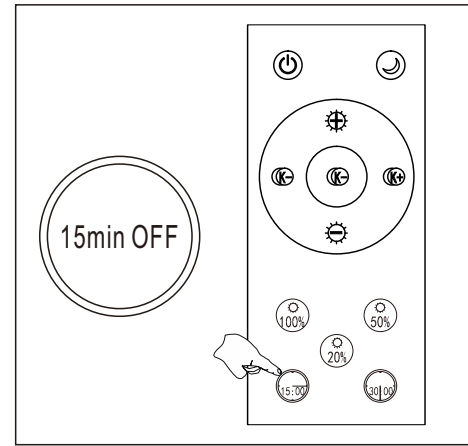
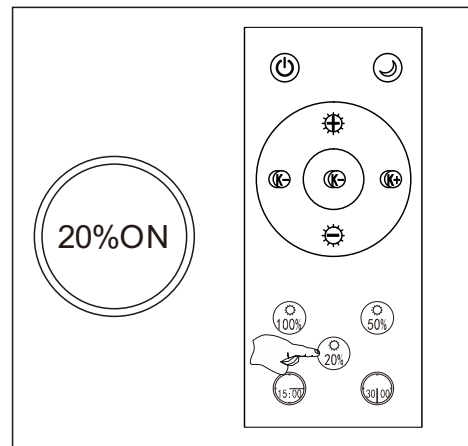
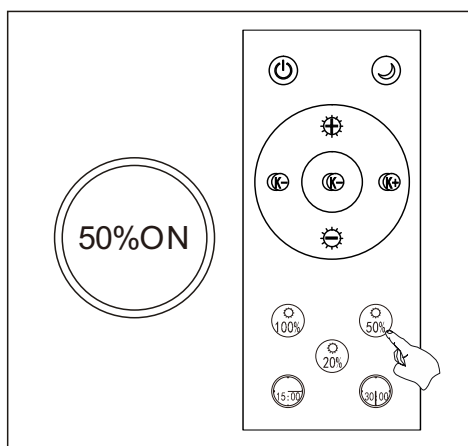
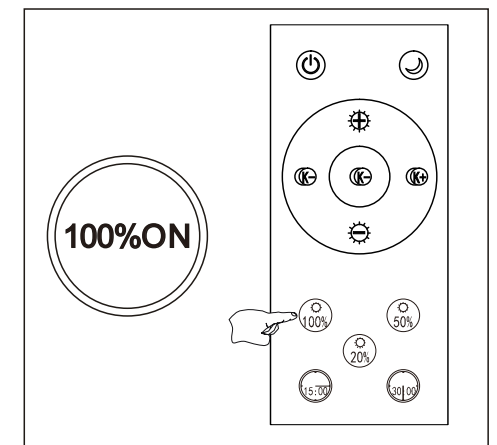
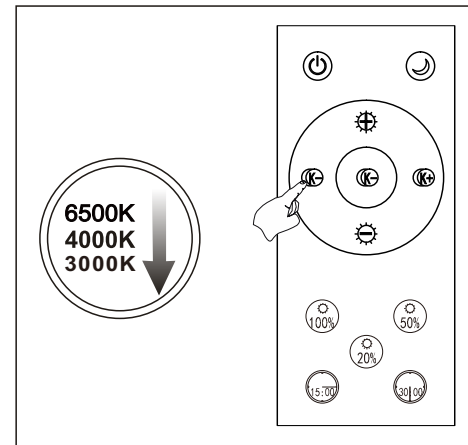
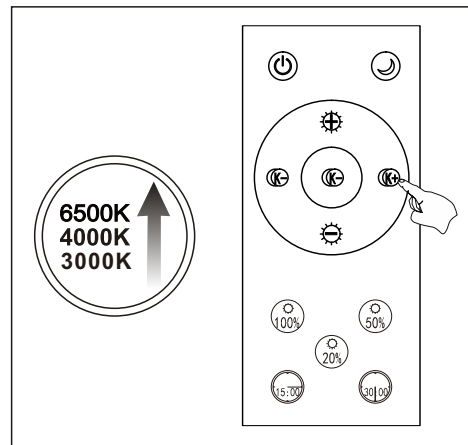
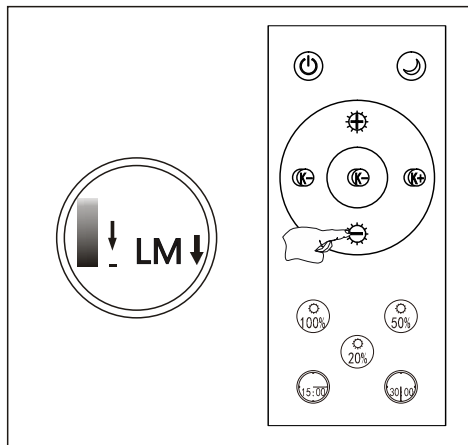
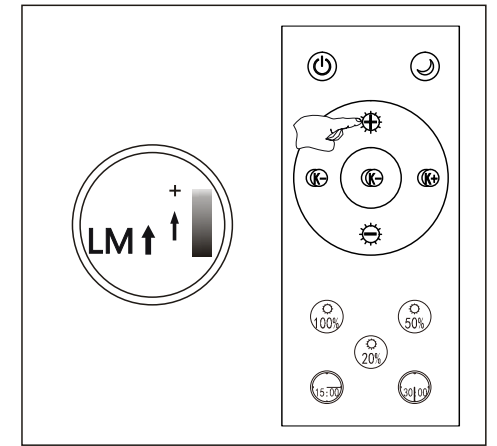
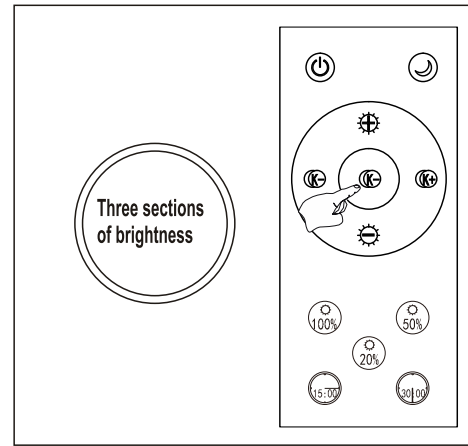
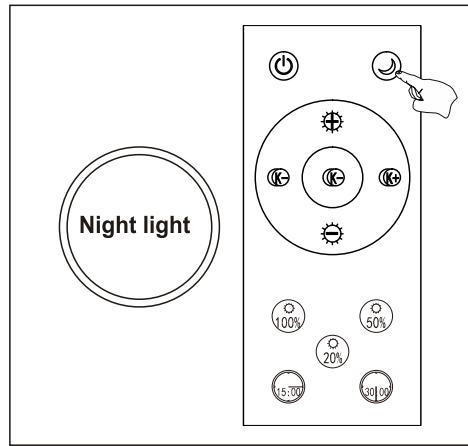
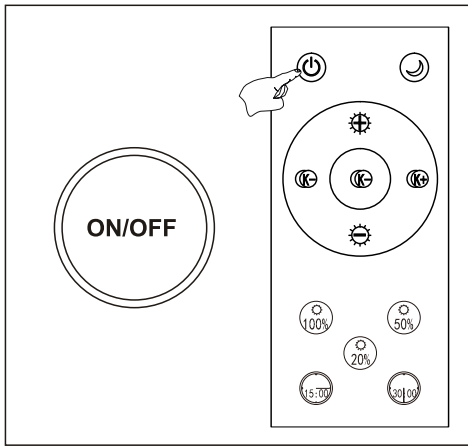

Lichtquelle:

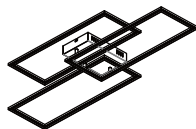

DEU:

Lichtquelle:

Die Lichtquelle ist nicht tauschbar, weil sie konstruktionsbedingt fest mit dem umgebenden Produkt verbunden ist.

Dieses Produkt enthält eine Lichtquelle der Energieeffizienzklasse <F>.

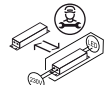

Austausch des Betriebsgeräts durch einen Professionisten.

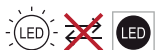

Leuchtmittel nicht austauschbar.

GBR:

Light source:

The light source is not interchangeable because it is determined by the surrounding product design. This product contains a light source of energy efficiency class <F>.

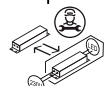

Replaceable control gear by a professional.

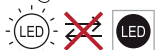

Non replaceable light source.

BIH:

Izvor svjetla :

Izvor svjetla nije zamjenjiv , jer je konstrukcijski pričvršćen na proizvod .
Ovaj proizvod sadržava izvor svjetlosti klase energetske učinkovitosti <F>.



Izmjenu pogonskog uređaja smije izvršiti i samo profesionalna osoba

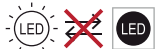

LED žarulje nije moguće zamjeniti

BG:

Източник на светлина:

Източникът на светлина не може да се подменя, тъй като поради конструкцията си е трайно фиксиран към заобикалящия го продукт.

Този продукт включва светлинен източник с клас на енергийна ефективност <F>.

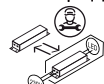

Смяна на управляващото устройство от професионалист.

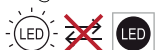

Източникът на светлина не може да се подменя.

CZ:

Zdroj světla:

Světelný zdroj není možné vyměnit, protože je díky své konstrukci pevně spojený s produktem.

Tento výrobek obsahuje světelný zdroj s třídou energetické účinnosti <F>.

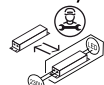

Výměna předřadníku jen odborníkem.

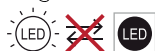

Světelný zdroj není vyměnitelný.

DK:

Lyskilde:

Lyskilden kan ikke udskiftes, fordi den er fast forbundet med det omgivende produkt. Dette produkt indeholder en lyskilde i energieffektivitetsklasse < F >.

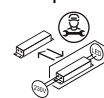

Enheden skal skiftes af en fagperson.

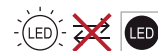

Lyskilden kan ikke udskiftes.

ET:

Valgusallikas:

Valgusallikas ei ole välja vahetatav, sest ta on tootega ehituslikult kindlalt seotud.

Toode sisaldab energiatõhususe klassi <F> valgusallikat.

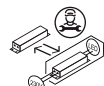

Juhtimiseadise välja vahetamine professionaali poolt.

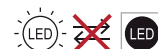

Lamp ei ole välja vahetatav.

FI:

Valonlähde:

Valonlähdettä ei voi vaihtaa uuteen, sillä se on rakenteellisesti yhdistetty ympäröivään tuotteeseen.

Tämä tuote sisältää valonlähteen, jonka energiatehokkuusluokka on <F>.

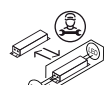

Liitäntälaitteen vaihtaa ammattilainen.

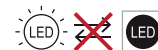

Valonlähdettä ei voi vaihtaa.

FR:

Source lumineuse:

La source lumineuse n'est pas remplaçable car elle est, de par la construction du produit, liée de façon permanente à celui-ci.

Ce produit contient une source lumineuse de classe d'efficacité énergétique <F>.



Remplacement du dispositif de commande par un professionnel.

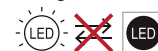

Ampoule non remplaçable.

GR:

Φωτεινή πηγή:

Η φωτεινή πηγή δεν μπορεί να αντικατασταθεί, επειδή είναι για κατασκευαστικούς λόγους σταθερά συνδεδεμένη με το προϊόν που την περιβάλλει.

Το προϊόν αυτό περιέχει φωτεινή πηγή της τάξης ενεργειακής απόδοσης <F>.



Αντικατάσταση της διάταξης λειτουργίας από έναν επαγγελματία

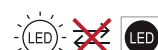

Ο λαμπτήρας δεν μπορεί να αντικατασταθεί.

HU:**Fényforrás:**

A fényforrás nem cserélhető, mert felépítése miatt szilárdan csatlakozik a termékhez. Ez a termék egy <F> energiahatékonysági osztályú fényforrást tartalmaz.

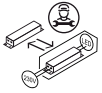

Az előtétet csak szakértők cserélhetik ki.



A fényforrás nem cserélhető

Isländisch/IS:**Ljósgrjafi:**

Ljósgrjafinn er ekki útskiptanlegur vegna þess að hann er háður umliggjandi hönnun vörunnar.

Varan inniheldur ljósgrjafa í orkuflokki <F>.

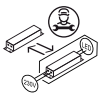

Útskiptanlegur stýribúnaður sem fagmaður á að framkvæma.



Ekki útskiptanlegur ljósgrjafi.

IT:**Sorgente luminosa:**

La sorgente luminosa non è intercambiabile perché è saldamente collegata al prodotto per via del suo design.

Questo prodotto contiene una sorgente luminosa di classe di efficienza energetica <F>.

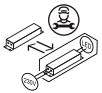

Sostituzione dell'alimentatore da parte di un professionista.



Lampadine non intercambiabili.

HR:**Izvor svjetla:**

Izvor svjetla nije zamjenjiv, jer je konstrukcijski pričvršćen na proizvod.

Ovaj proizvod sadržava izvor svjetlosti klase energetske učinkovitosti <F>.

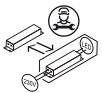

Izmjenu pogonskog uređaja smije izvršiti i samo profesionalna osoba



LED žarulje nije moguće zamjeniti

LV:**Gaismas avots:**

Gaismas avotu nevar nomainīt, jo tas konstrukcijā ir cieši savienots ar izstrādājuma apkārtējo daļu.

Šis ražojums satur gaismas avotu, kura energoefektivitātes klase ir <F>.

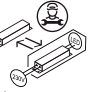

Vadības ierīci var nomainīt speciālists.



Apgaismes līdzekli nevar nomainīt.

LT:**Šviesos šaltinis:**

Šis šviesos šaltinis yra nekeičiamas, nes jis prijungtas prie gaminio pagal jo konstrukciją. Šiame gaminyje yra šviesos šaltinis, kurio energijos vartojimo efektyvumo klasė <F>.

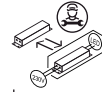

Valdymo įtaisą keičia profesionalas.



Šviesos šaltinis yra nekeičiamas.

NL:**Lichtbron:**

De lichtbron kan niet worden vervangen, omdat deze vanwege de constructie vast met het product eromheen verbonden is.

Dit product bevat een lichtbron van energie-efficiëntieklasse <F>.

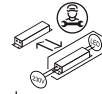

Vervanging van het apparaat door een expert.



Verlichting kan niet worden vervangen.

Norwegisch/Norwegian / NO:**Lyskilde:**

Lyskilden kan ikke byttes fordi den sitter fast i produktet.

Dette produktet inneholder en lyskilde i energiklasse <F>.

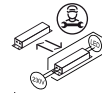

Bytte av driftsapparatet må gjøres av fagmann.



Lyskilden kan ikke byttes ut.

PL:**Źródło światła:**

Źródła światła nie można wymienić, ponieważ jest zintegrowane z produktem ze względu na swoją konstrukcję.

Ten produkt zawiera źródło światła o klasie efektywności energetycznej <F>.

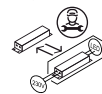

Wymiana osprzętu sterującego wyłącznie przez specjalistę.



Źródła światła nie można wymienić.

PT:**Fonte de Luz:**

A fonte de luz não é substituível porque devido às suas características construtivas está fixada de forma permanente ao produto circundante.

Este produto contém uma fonte de luz da classe de eficiência energética <F>.

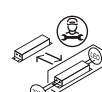

Substituição do dispositivo de comando por parte de um profissional.



Lâmpada não substituível.

RO:Sursa de lumina:

Sursa de lumina nu este inlocuibilă ea fiind parte constructivă a produsului
Acest produs conține o sursă de lumină cu clasa de eficiență energetică <F>.

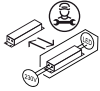

Schimbarea unitatii de control trebuie facuta doar de catre personal specializat

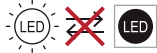

Sursa de lumina nu poate fi schimbata

RUS:Источник света:

Источник света не является взаимозаменяемым, поскольку это определяется конструкцией смежного продукта.

Данный продукт содержит источник света класса энергоэффективности <F>.

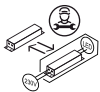

Замена регулировочного механизма специалистом.



Незаменяемый источник света.

SRB:Izvor svetlosti:

Izvor svetlosti nije zamenljiv, jer je zbog svog dizajna čvrsto povezan sa proizvodom koji ga opkružuje.
Ovaj proizvod sadrži izvor svetlosti klase energetske efikasnosti <F>.

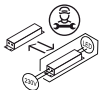

Zamena upravljačkog uređaja od strane profesionalca.



Izvor svetlosti se ne može zameniti.

SK:Zdroj svetla:

Svetelný zdroj nie je možné vymeniť, pretože je vďaka svojej konštrukcii pevne spojený s produktom
Tento výrobok obsahuje svetelný zdroj triedy energetickej účinnosti <F>.

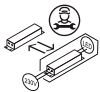

Výmena predradníka len odborníkom.

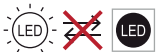

Svetelný zdroj nie je vymeniteľný.

SI:Izvor svetlobe:

Vir svetlobe ni zamenljiv, ker je določen z zasnovno izdelka v okolici.
Ta izdelek vsebuje svetlobni vir razreda energijske učinkovitosti <F>.

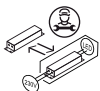

Zamenljiv krmilnik s strani strokovne osebe.

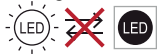

Nezamenljiv vir svetlobe.

ES:Fuente de luz:

La fuente de luz no es sustituible porque está fija en el producto desde la construcción.
Este producto contiene una fuente luminosa de la clase de eficiencia energética <F>.



Sustitución del aparato por un profesional.

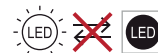

Bombilla no reemplazable.

SE:Ljuskälla:

Ljuskällan är inte utbytbar, eftersom den på grund av konstruktionen är fast integrerad i den omgivande produkten.

Denna produkt innehåller en ljuskälla med energieffektivitetsklass <F>.



Byte av driftdonet genom en fackman.

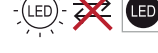

Ljuskällan är inte utbytbar.

TR:Işık kaynağı:

Konstrüksiyon gereği çevreleyen ürün ile sabit bir şekilde bağlı olduğu için ışık kaynağı değiştirilemez.
Bu ürün, <F> enerji sınıfından bir ışık kaynağına sahiptir.



İşletme cihazının bir profesyonel tarafından değiştirilmesi.



Aydınlatma malzemesi değiştirilemez.

UK:Джерело світла:

Джерело світла не можна обміняти, оскільки воно міцно пов'язане з навколишнім виробом завдяки своїй конструкції.

Цей виріб містить джерело світла класу енергоефективності <F>.



Заміна контрольної передачі професіоналом.

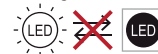

Цибулини не взаємозамінні.