

# GLOBO

LIGHTING

www.globo-lighting.com

67195D

**B**

- colour fixing 2700k-6500k
- many steps 3 LIGHT STEPS 4000k 6500k 2700K
- timer memory function
- incl. night light
- dimmable

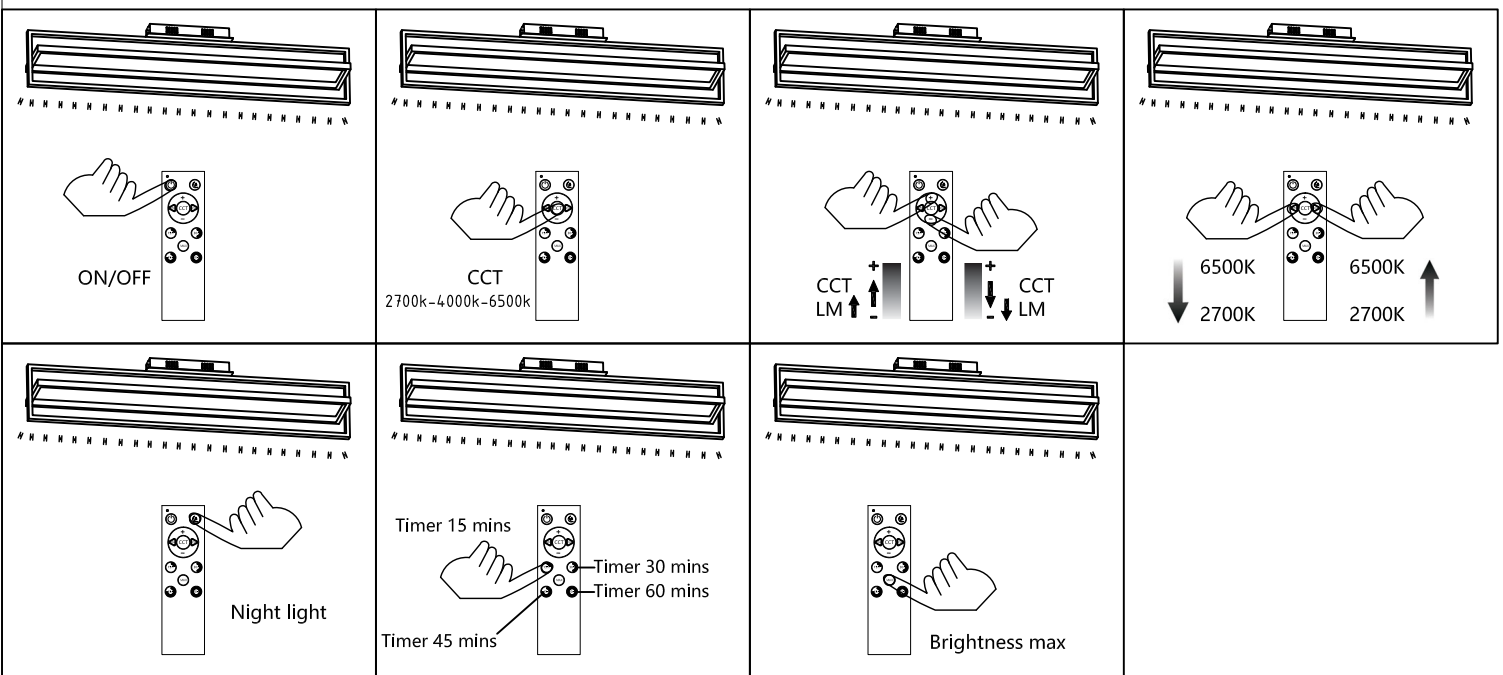
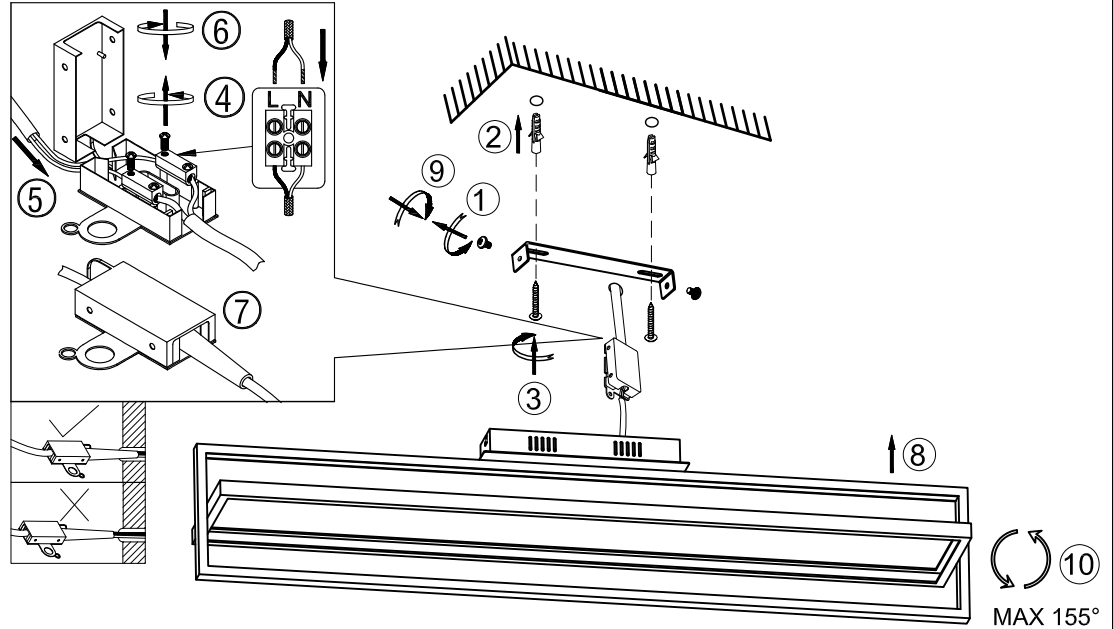

LED 23W SMD 30-36V 220-240V~ 50/60Hz	
Frequency Bandwidth	Maximal radiation transmitting power
2.402~2.480GHz	10dBm

GLOBO Handels GmbH  
Gewerbestr. 3  
A-9184 Sankt Peter Austria

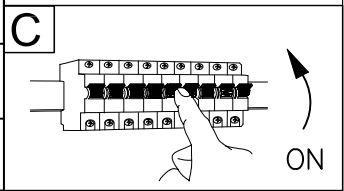

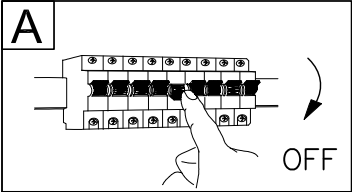

# GLOBO

LIGHTING

[www.globo-lighting.com](http://www.globo-lighting.com)

67195D

**B**

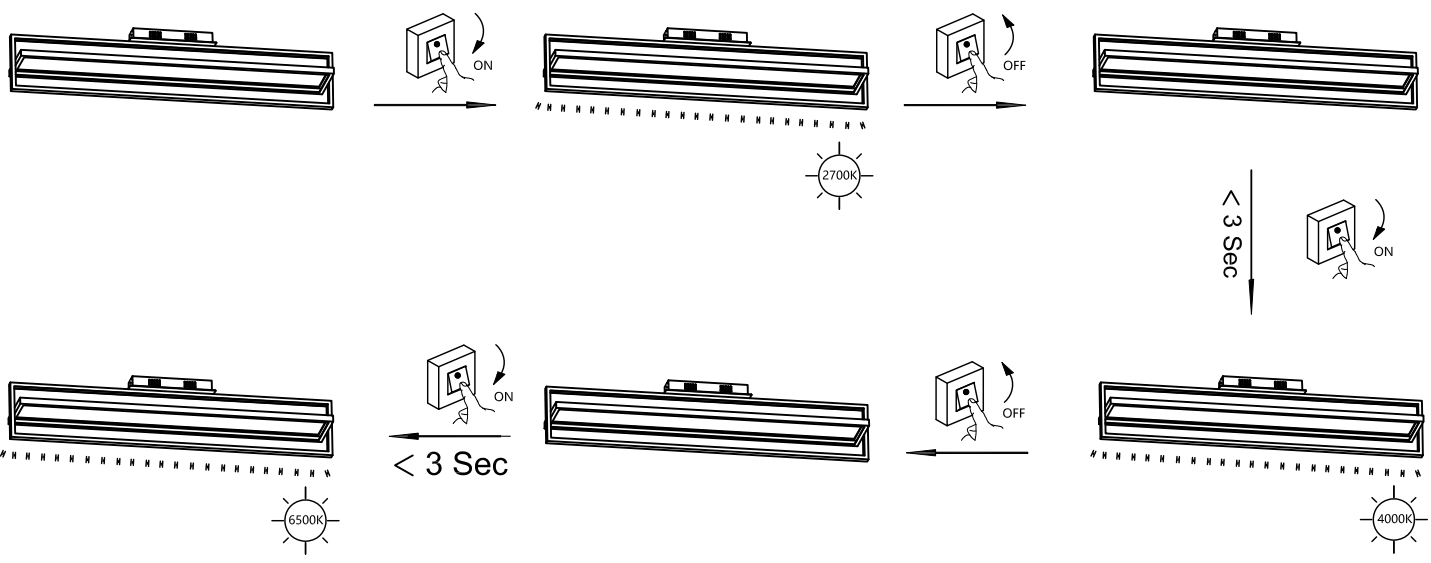

GLOBO Handels GmbH  
 Gewerbestrasse 3  
 A-9184 Sankt Peter Austria

LED 23W SMD 30-36V 220-240V~ 50/60Hz	
Frequency Bandwidth	Maximal radiation transmitting power
2.402~2.480GHz	10dBm

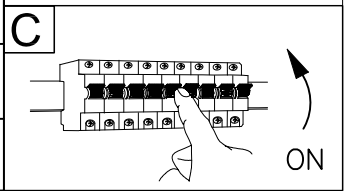

## Lichtquelle:

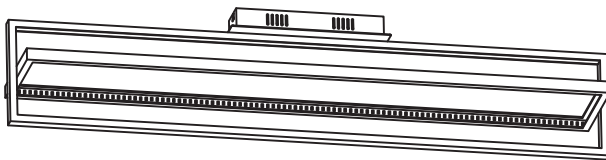

### DEU:

#### Lichtquelle:

Die Lichtquelle ist nicht tauschbar, weil sie konstruktionsbedingt fest mit dem umgebenden Produkt verbunden ist.

Dieses Produkt enthält eine Lichtquelle der Energieeffizienzklasse <F>.

  Die LED - Lichtquelle ist nicht austauschbar.



 Das Betriebsgerät ist nicht austauschbar.

### GBR:

#### Light source:

The light source is not interchangeable because it is determined by the surrounding product design.

This product contains a light source of energy efficiency class <F>.

  The LED - light source cannot be replaced.



 The control gear cannot be replaced.

### BIH&HR:

#### Izvor svjetla :

Izvor svjetla nije zamjenjiv , jer je konstrukcijski pričvršćen na proizvod .

Ovaj proizvod sadržava izvor svjetlosti klase energetske učinkovitosti <F>.

  LED – izvor svjetla nije moguće zamjeniti



 Pogonski uređaj se ne može zamjeniti .

### BG:

#### Източник на светлина:

Източникът на светлина не може да се подменя, тъй като поради конструкцията си е трайно фиксиран към заобикалящия го продукт.

Този продукт включва светлинен източник с клас на енергийна ефективност <F>.

  LED източникът на светлина не може да се подменя.



 Устройството за управление не може да се подменя.

### CZ:

#### Zdroj světla:

Světelný zdroj není možné vyměnit, protože je díky své konstrukci pevně spojený s produktem.

Tento výrobek obsahuje světelný zdroj s třídou energetické účinnosti <F>.

  Světelný zdroj není vyměnitelný.



 Předřadník není vyměnitelný.

### DK:

#### Lyskilde:

Lyskilden kan ikke udskiftes, fordi den er fast forbundet med det omgivende produkt.

Dette produkt indeholder en lyskilde i energieffektivitetsklasse <F>.

  LED- lyskilden kan ikke udskiftes.



 Driftsenheden kan ikke udskiftes.

### ET:

#### Valgusallikas:

Valgusallikas ei ole välja vahetatav, sest ta on tootega ehituslikult kindlalt seotud.

Toode sisaldab energiatõhususe klassi <F> valgusallikat.

  LED - valgusallikat ei saa asendada.

 Juhtseadet ei saa asendada.

### FI:

#### Valonlähde:

Valonlähdettä ei voi vaihtaa uuteen, sillä se on rakenteellisesti yhdistetty ympäröivään tuotteeseen.

Tämä tuote sisältää valonlähteen, jonka energiatehokkuusluokka on <F>.

  LED-valonlähdettä ei voi vaihtaa uuteen.



 Liitäntälaitetta ei voi vaihtaa uuteen.

### FR:

#### Source lumineuse:

La source lumineuse n'est pas remplaçable car elle est, de par la construction du produit, liée de façon permanente à celui-ci.

Ce produit contient une source lumineuse de classe d'efficacité énergétique <F>.

  La source lumineuse LED n'est pas remplaçable.

 L'unité de contrôle n'est pas remplaçable.

**GR:**

Φωτεινή πηγή:

Η φωτεινή πηγή δεν μπορεί να αντικατασταθεί, επειδή είναι για κατασκευαστικούς λόγους σταθερά συνδεδεμένη με το προϊόν που την περιβάλλει.

Το προϊόν αυτό περιέχει φωτεινή πηγή της τάξης ενεργειακής απόδοσης <F>.



Η φωτεινή πηγή LED δεν αντικαθίσταται.

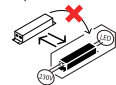

Η λειτουργική συσκευή δεν αντικαθίσταται.

**HU:**

Fényforrás:

A fényforrás nem cserélhető, mert felépítése miatt szilárdan csatlakozik a termékhez. Ez a termék egy <F> energiahatékonysági osztályú fényforrást tartalmaz.



A fényforrás nem cserélhető.

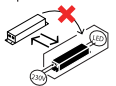

Az előtét nem cserélhető.

**Isländisch/IS:**

Ljósgrjafi:

Ljósgrjafinn er ekki útskiptanlegur vegna þess að hann er háður umliggjandi hönnun vörunnar.

Varan inniheldur ljósgrjafa í orkuflokki <F>.

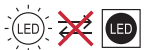

Ekki er hægt að skipta um LED-ljósgrjafann.

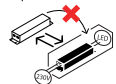

Ekki er hægt að skipta um stjórnbúnaðinn.

**IT:**

Sorgente luminosa:

La sorgente luminosa non è intercambiabile perché è saldamente collegata al prodotto per via del suo design.

Questo prodotto contiene una sorgente luminosa di classe di efficienza energetica <F>.



La sorgente luminosa a LED non può essere sostituita.

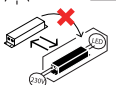

La centralina non può essere sostituita.

**LV:**

Gaismas avots:

Gaismas avotu nevar nomainīt, jo tas konstrukcijā ir cieši savienots ar izstrādājuma apkārtējo daļu.

Šis ražojums satur gaismas avotu, kura energoefektivitātes klase ir <F>.



LED apgaismes līdzekli nevar nomainīt.

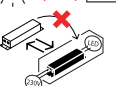

Vadības ierīci nevar nomainīt.

**LT:**

Šviesos šaltinis:

Šis šviesos šaltinis yra nekeičiamas, nes jis prijungtas prie gaminio pagal jo konstrukciją.

Šiame gaminyje yra šviesos šaltinis, kurio energijos vartojimo efektyvumo klasė <F>.



LED šviesos šaltinis yra nekeičiamas.

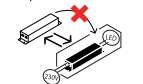

Valdymo įtaisas yra nekeičiamas.

**NL:**

Lichtbron:

De lichtbron kan niet worden vervangen, omdat deze vanwege de constructie vast met het product eromheen verbonden is.

Dit product bevat een lichtbron van energie-efficiëntieklasse <F>.

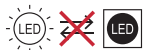

De LED-lichtbron kan niet worden vervangen.

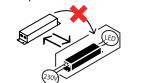

Het apparaat kan niet worden vervangen.

**Norwegisch/Norwegian / NO:**

Lyskilde:

Lyskilden kan ikke byttes fordi den sitter fast i produktet.

Dette produktet inneholder en lyskilde i energiklasse <F>.



LED-lyspæren kan ikke byttes.

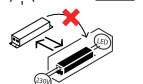

Driverenheten kan ikke byttes.

**PL:**

Źródło światła:

Źródło światła nie można wymienić, ponieważ jest zintegrowane z produktem ze względu na swoją konstrukcję.

Ten produkt zawiera źródło światła o klasie efektywności energetycznej <F>.



LED - źródło światła nie może być wymienione.

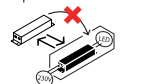

Nie można wymienić przekładni sterującej.

**PT:**

Fonte de Luz:

A fonte de luz não é substituível porque devido às suas características construtivas está fixada de forma permanente ao produto circundante.

Este produto contém uma fonte de luz da classe de eficiência energética <F>.



Lâmpada não substituível.

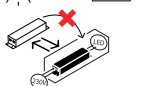

Equipamento de controlo não substituível.

**RO:**

**Sursa de lumina:**

Sursa de lumina nu este inlocuibilă ea fiind parte constructivă a produsului  
Acest produs conține o sursă de lumină cu clasă de eficiență energetică <F>.

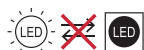

Sursa de lumina nu poate fi înlocuită

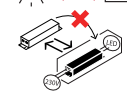

Driverul nu poate fi înlocuit

**RUS:**

**Источник света:**

Источник света не является взаимозаменяемым, поскольку это определяется конструкцией смежного продукта.

Данный продукт содержит источник света класса энергоэффективности <F>.

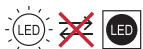

Светодиодный источник света не подлежит замене.

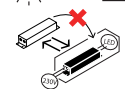

Устройство управления не подлежит замене.

**SRB:**

**Izvor svetlosti:**

Izvor svetlosti nije zamenljiv, jer je zbog svog dizajna čvrsto povezan sa proizvodom koji ga opkružuje.

Ovaj proizvod sadrži izvor svetlosti klase energetske efikasnosti <F>.

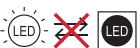

LED izvor svetlosti nije zamenljiv.

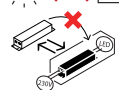

Upravljački uređaj nije zamenljiv.

**SK:**

**Zdroj svetla:**

Svetelný zdroj nie je možné vymeniť, pretože je vďaka svojej konštrukcii pevne spojený s produktom.

Tento výrobok obsahuje svetelný zdroj triedy energetickej účinnosti <F>.



Svetelný zdroj nie je vymeniteľný.

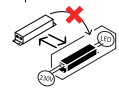

Predradník nie je vymeniteľný.

**SI:**

**Izvor svetlobe:**

Vir svetlobe ni zamenljiv, ker je določen z zasnovo izdelka v okolici.

Ta izdelek vsebuje svetlobni vir razreda energijske učinkovitosti <F>.

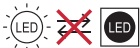

Svetlobni vir ni mogoče zamenjati.

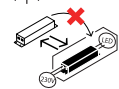

Krmilnik ni mogoče zamenjati.

**ES:**

**Fuente de luz:**

La fuente de luz no es sustituible porque está fija en el producto desde la construcción.

Este producto contiene una fuente luminosa de la clase de eficiencia energética <F>.

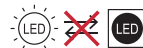

Bombilla no reemplazable.

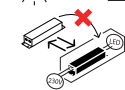

Dispositivo de control no reemplazable.

**SE:**

**Ljuskälla:**

Ljuskällan är inte utbytbar, eftersom den på grund av konstruktionen är fast integrerad i den omgivande produkten.

Denna produkt innehåller en ljuskälla med energieffektivitetsklass <F>.



LED-ljuskällan kan inte bytas ut.

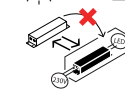

Driftdonet kan inte bytas ut.

**TR:**

**Işık kaynağı:**

Konstrüksiyon gereği çevreleyen ürün ile sabit bir şekilde bağlı olduğu için ışık kaynağı değiştirilemez.

Bu ürün, <F> enerji sınıfından bir ışık kaynağına sahiptir.



LED ışık kaynağı değiştirilemez.

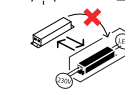

İşletme cihazı değiştirilemez.

**UK:**

**Джерело світла:**

Джерело світла не можна обміняти, оскільки воно міцно пов'язане з навколишнім виробом завдяки своїй конструкції.

Цей виріб містить джерело світла класу енергоефективності <F>.



джерело світлодіодного світла не можна замінювати.

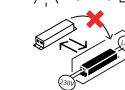

пристрій керування не можна замінювати.