

A

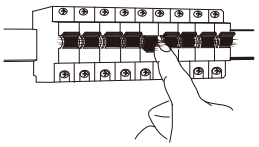

LED MAX 110W 35V
220-240V~ 50/60Hz

Frequency Bandwidth	Maximal radiation transmitting power
2410-2475MHz	-0.7dBm

OFF

GLOBO
LIGHTING
www.globo-lighting.com

67191-110

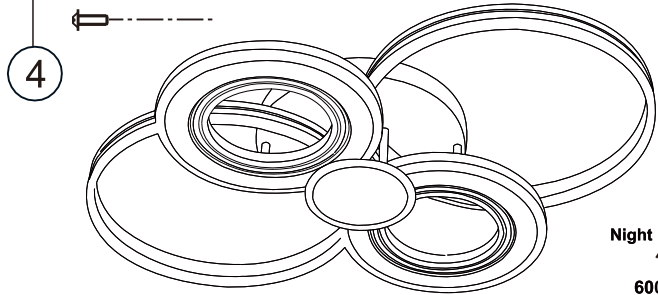
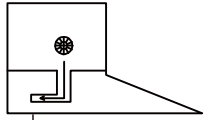
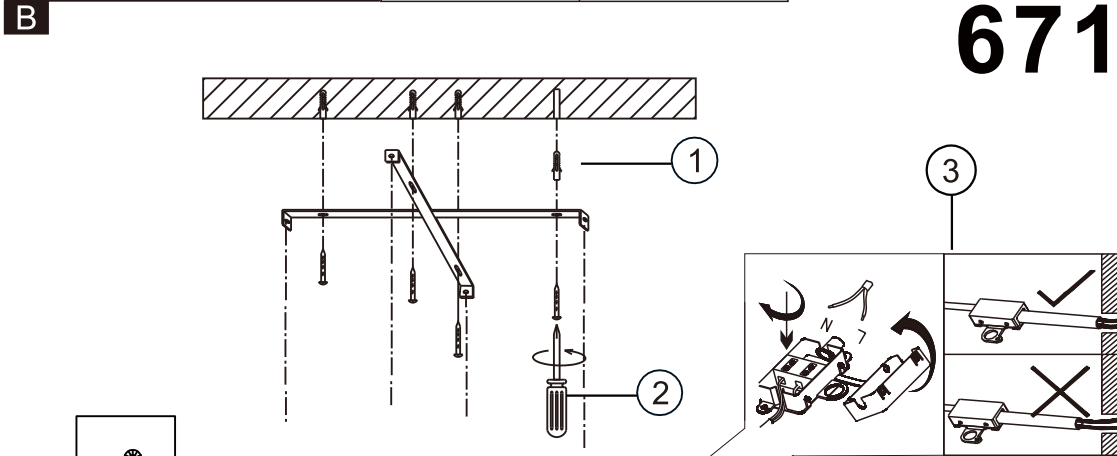

ON
LM ↑
6000K

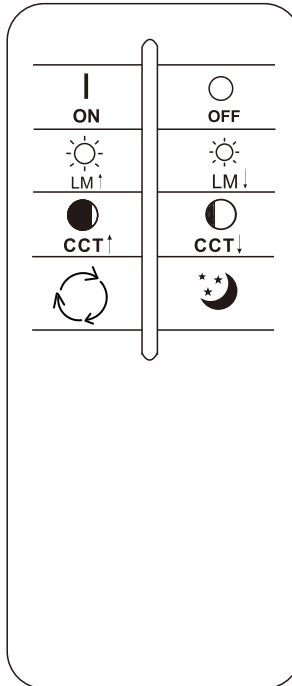

OFF
LM ↓
2700K

Night light



Night light → 2700K
6000K ← 4000K

- memory function
- 4000 K **3** LIGHT STEPS 6000 K 2700K
- 2700K-6000K
- night light
- dimmable
- colour fixing
- incl. (remote control icon)
- many light steps
- many steps

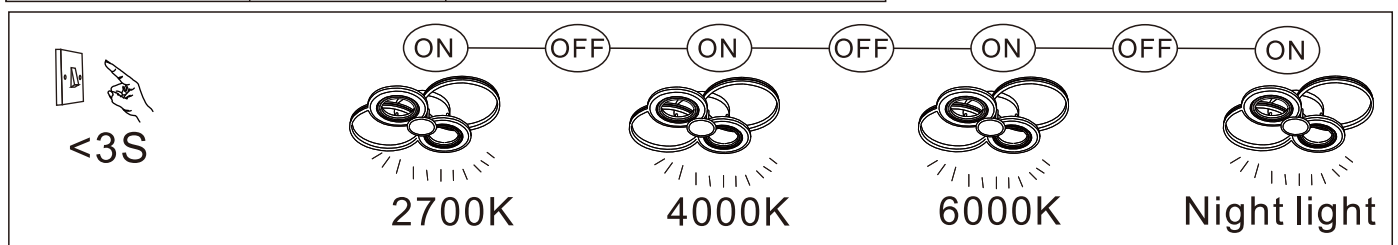
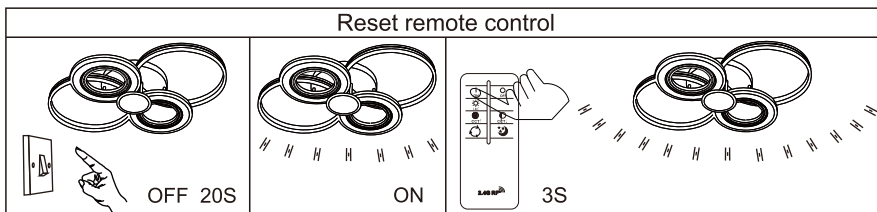

GLOBO Handels GmbH
Gewerbestr. 3
A-9184 Sankt Peter
AUSTRIA

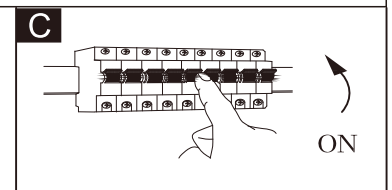

Lichtquelle/Light source:

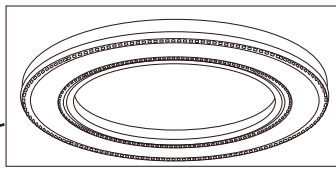
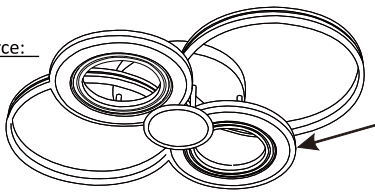

DEU:

Lichtquelle:

Die Lichtquelle ist nicht tauschbar, weil sie konstruktionsbedingt fest mit dem umgebenden Produkt verbunden ist.

Dieses Produkt enthält eine Lichtquelle der Energieeffizienzklasse <E>.



Die LED - Lichtquelle ist nicht austauschbar.



Das Betriebsgerät kann nur durch einen Fachmann ausgetauscht werden.

GBR:

Light source:

The light source is not interchangeable because it is determined by the surrounding product design. This product contains a light source of energy efficiency class <E>.



The LED - light source cannot be replaced.



The control gear can be replaced by a professional.

BIH:

Izvor svjetla :

Izvor svjetla nije zamjenjiv , jer je konstrukcijski pričvršćen na proizvod .

Ovaj proizvod sadržava izvor svjetlosti klase energetske učinkovitosti <E>.



LED – izvor svjetla nije moguće zamjeniti



Pogonski uređaj smije zamjeniti samo stručna osoba .

BG:

Източник на светлина:

Източникът на светлина не може да се подменя, тъй като поради конструкцията си е трайно фиксиран към заобикалящия го продукт.

Този продукт включва светлинен източник с клас на енергийна ефективност <E>.



LED източникът на светлина не може да се подменя.



Устройството за управление може да се подменя само от специалист.

CZ:

Zdroj světla:

Světelný zdroj není možné vyměnit, protože je díky své konstrukci pevně spojený s produktem.

Tento výrobek obsahuje světelný zdroj s třídou energetické účinnosti <E>.



Světelný zdroj není vyměnitelný.



Výměna předradníku pouze odborníkem

DK:

Lyskilde:

Lyskilden kan ikke udskiftes, fordi den er fast forbundet med det omgivende produkt.

Dette produkt indeholder en lyskilde i energieffektivitetsklasse < E >.



LED- lyskilden kan ikke udskiftes.



Driftsenheden kan kun skiftes af en fagperson.

ET:

Valgusallikas:

Valgusallikas ei ole välja vahetatav, sest ta on tootega ehituslikult kindlalt seotud.

Toode sisaldab energiatõhususe klassi <E> valgusallikat.



LED - valgusallikat ei saa asendada.



Juhtseadmed võib asendada professionaalne.

FI:

Valonlähde:

Valonlähdeä ei voi vaihtaa uuteen, sillä se on rakenteellisesti yhdistetty ympäröivään tuoteeseen.

Tämä tuote sisältää valonlähteen, jonka energiatehokkuusluokka on <E>.



LED-valonlähdeä ei voi vaihtaa uuteen.



Vain ammattihenkilö voi vaihtaa liitäntälaitteen.

FR:

Source lumineuse:

La source lumineuse n'est pas remplaçable car elle est, de par la construction du produit, liée de façon permanente à celui-ci.

Ce produit contient une source lumineuse de classe d'efficacité énergétique <E>.



La source lumineuse LED n'est pas remplaçable.



L'unité de contrôle ne peut être remplacée que par un spécialiste.

GR:

Φωτεινή πηγή:

Η φωτεινή πηγή δεν μπορεί να αντικατασταθεί, επειδή είναι για κατασκευαστικούς λόγους σταθερά συνδεδεμένη με το προϊόν που την περιβάλλει.

Το προϊόν αυτό περιέχει φωτεινή πηγή της τάξης ενεργειακής απόδοσης <E>.



Η φωτεινή πηγή LED δεν αντικαθίσταται.



Η λειτουργική ουσμική μπορεί να αντικατασταθεί μόνο από ΕΠΩΝ ΕΙΣΑΓ.

HU:

Fényforrás:

A fényforrás nem cserélhető, mert felépítése miatt szilárdan csatlakozik a termékhez.

És a termék egy <E> energiatékonysági osztályú fényforrást tartalmaz.



A fényforrás nem cserélhető



Az előlétet csak szakértők cserélhetik ki.

Isländisch/IS:

Ljósgrafi:

Ljósgraffinn er ekki útskiptanlegur vegna þess að hann er háður umliggjandi hönnu vörnum.

Varan inniheldur ljósgrafa í orkuflökki <E>.



Ekki er hægt að skipta um LED-ljósgrafa.



Aðeins fagmenn mega skipta um stjórnbúnaðinn.

IT:

Sorgente luminosa:

La sorgente luminosa non è intercambiabile perché è saldamente collegata al prodotto per via del suo design.

Questo prodotto contiene una sorgente luminosa di classe di efficienza energetica <E>.



La sorgente luminosa a LED non può essere sostituita.



L'alimentatore può essere sostituito solo da personale specializzato.

HR:

Izvor svjetla :

Izvor svjetla nije zamjenjiv , jer je konstrukcijski pričvršćen na proizvod .

Ovaj proizvod sadržava izvor svjetlosti klase energetske učinkovitosti <E>



LED – izvor svjetla nije moguće zamjeniti



Pogonski uređaj smije zamjeniti samo stručna osoba .

LV:

Gaismas avots:

Gaismas avotu nevar nomainīt, jo tas konstrukcijā ir cieši savienots ar izstrādājuma apkārtējo daļu.

Šis ražojums satur gaismas avotu, kura energoefektivitātes klase ir <E>.



LED apgaismes līdzekli nevar nomainīt.



Vadības ierīci var nomainīt speciālists.

LT:

Šviesos šaltinis:

Šis šviesos šaltinis yra nekeičiamas, nes jis prijungtas prie gaminio pagal jo konstrukciją.

Šiame gaminyje yra šviesos šaltinis, kurio energijos vartojimo efektyvumo klasė <E>.



LED šviesos šaltinis yra nekeičiamas.



Valdymo įtaisu gali pakeisti tik tam kvalifikuotas specialistas.

NL:

Lichtbron:

De lichtbron kan niet worden vervangen, omdat deze vanwege de constructie vast met het product eromheen verbonden is.

Dit product bevat een lichtbron van energie-efficiëntieklasse <E>.



De LED-lichtbron kan niet worden vervangen.



Het apparaat kan alleen door een vakman worden vervangen.

Norwegisch/Norwegian / NO:

Lyskilde:

Lyskilden kan ikke byttes fordi den sitter fast i produktet.

Dette produktet inneholder en lyskilde i energiklasse <E>.



LED-lyspæren kan ikke byttes.



Drivereheten kan kun byttes av fagmann.

PL:

Źródło światła:

Źródła światła nie można wymienić, ponieważ jest zintegrowane z produktem ze względu na swoją konstrukcję.

Ten produkt zawiera źródło światła o klasie efektywności energetycznej <E>.



LED - źródło światła nie może być wymienione.



Urządzenie sterujące może zostać wymienione przez specjalistę.

PT:

Fonte de Luz:

A fonte de luz não é substituível porque devido às suas características construída de forma permanente ao produto circundante.

Este produto contém uma fonte de luz da classe de eficiência energética <E>.



Lâmpada não substituível.



Substituição do equipamento de controlo por um profissional.

RO:

Sursa de lumina:

Sursa de lumina nu este inlocuibilă ea fiind parte constructivă a produsului. Acest produs conține o sursă de lumina cu clasa de eficiență energetică <E>.



Sursa de lumina nu poate fi înlocuită



Driverul poate fi înlocuit doar de către personal specializat

RUS:

Источник света:

Источник света не является взаимозаменяемым, поскольку это определяется конструкцией смежного продукта.

Данный продукт содержит источник света класса энергоэффективности <E>.



Светодиодный источник света не подлежит замене.



Устройство управления может заменяться только квалифицированным специалистом.

SRB:

Izvor svjetlosti:

Izvor svjetlosti nije zamjenjiv, jer je zbog svog dizajna čvrsto povezan sa proizvodom koji ga okružuje.

Ovaj proizvod sadrži izvor svjetlosti klase energetske efikasnosti <E>.



LED izvor svjetlosti nije zamjenjiv.



Upravljački uređaj može da zameni samo specijalista.

SK:

Zdroj svetla:

Světelný zdroj nie je možné vymeniť, pretože je vďaka svojej konštrukcii pevne spojený s produktom.

Tento výrobok obsahuje svetelný zdroj triedy energetickej účinnosti <E>.



Světelný zdroj nie je vymeniteľný.



Výměna předradníka len odborníkom.

SI:

Izvor svetlobe:

Vir svetlobe ni zamenljiv, ker je določen z zasnovno izdelka v okolici.

Ta izdelek vsebuje svetlobni vir razreda energetske učinkovitosti <E>.



Svetlobni vir ni mogoče zamenjati.



Výměna předradníka len odborníkom.

SE:

Ljuskälla:

Ljuskällan är inte utbytbar, eftersom den på grund av konstruktionen är fast integrerad i den omgivande produkten.

Denna produkt innehåller en ljuskälla med energieffektivitetsklass <E>.



LED-ljuskällan kan inte bytas ut.



Driftdonet kan endast bytas ut av en lackman.

TR:

Isik kaynağı:

Konstrüksiyon gereği çevreleyen ürün ile sabit bir şekilde bağlı olduğu için isik kaynağı deđiştirilemez.

Bu ürün, <E> enerji sınıfından bir isik kaynađına sahiptir.



LED isik kaynađı deđiştirilemez.



İşletme cihazı sadece bir uzman tarafından deđiştirilebilir.

UK:

Джерело світла:

Джерело світла не можна обмінити, оскільки воно міцно пов'язане з навколишнім виробом завдяки своїй конструкції.

Цей виріб містить джерело світла класу енергоефективності <E>.



— джерело світлодіодного світла не можна замінювати.



— лише фахівець може замінювати пристрій керування.